

RESIDENCE 7 COLLECTION - ANCILLARY PROFILES

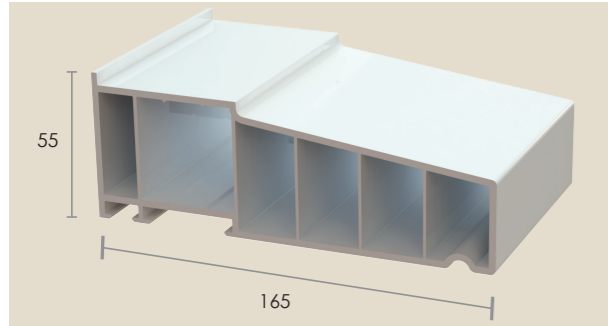

R009 55mm Radlington Cill
R324 55mm Radlington Cill End Cap pair



R009M 30mm Radlington Cill
R325 30mm Radlington Cill End Cap pair

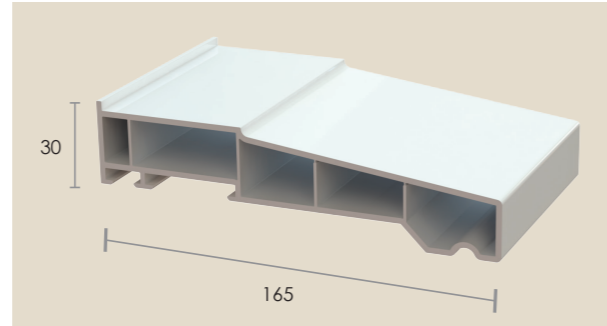

R007 180mm Cill
R311, R312 180mm Cill End Cap LH, RH

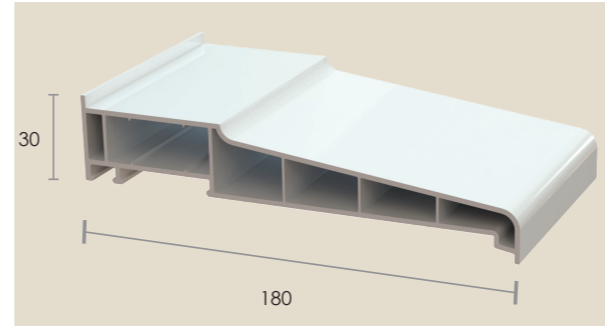

R008 95mm Stub Cill
R317, R318 95mm Stub Cill End Cap LH, RH

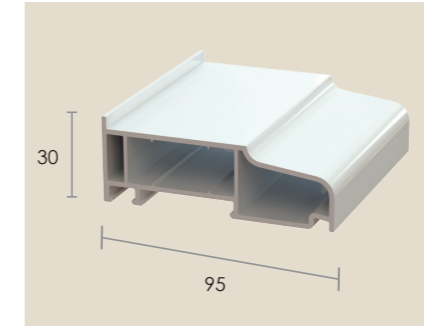

WERB009 PVCu Reinforcing
- use with R009

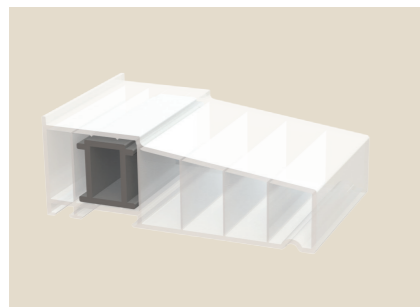

R209 PVCu Reinforcing
- use with 30mm Cills

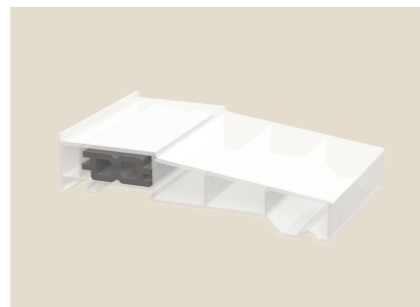

R217 Internal Cill Trims
- use with R007, R008, R009M
R214 Internal Cill Trim
- use with R009

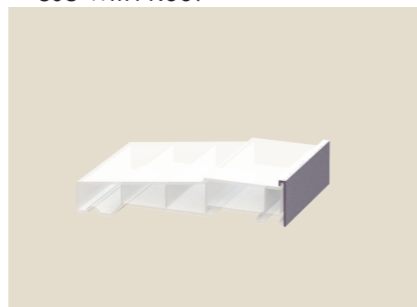

R213 PVC Trim 17.5mm Quadrant



R212 PVC Trim 25mm D Mould

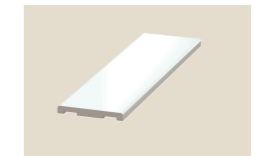

R207 PVC Trim 45mm Architrave

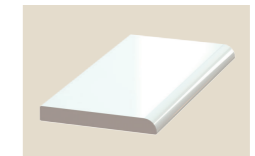

R7120 10mm In-Line Coupler
DBI Trim

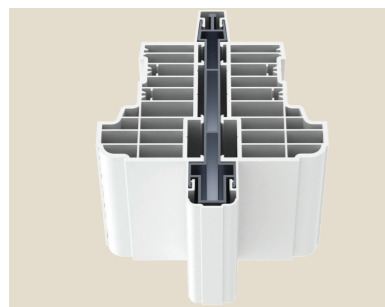

R7107 24mm In-Line Coupler
PILDT Trim
Jack B 482031

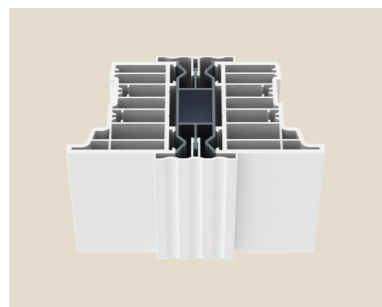

R7121 40mm In-Line Coupler
PILDT Trim

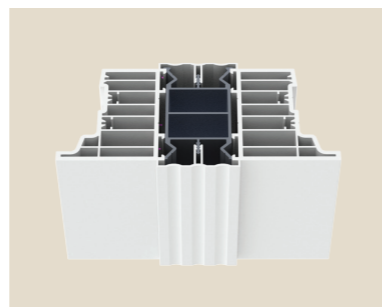

R78115 132mm In-Line Coupler
CPILDT Trim
Jack D VS

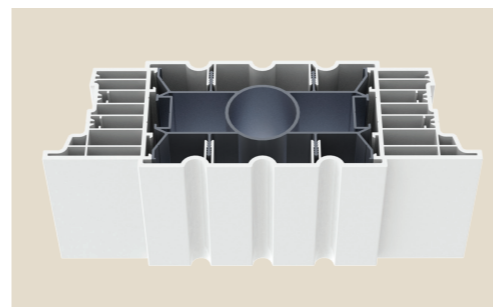

R78108 90° Corner Post
90SQ Square Corner Post Cover
Jack D WWL142

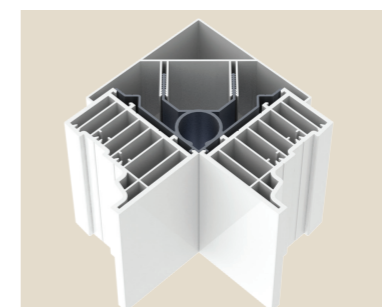

R211 PVC Trim
150mm x 9mm Soffit Board



WWL121 94°-125° Variable Bay Post
482104 Frame Adapter
DBI, DBO120 Internal, External Trim
Jack C



R7109 120°-165° Variable Bay Post
482028 Frame Adapter
PILDT, DBO120 Internal, External Trim
Jack D WWL142

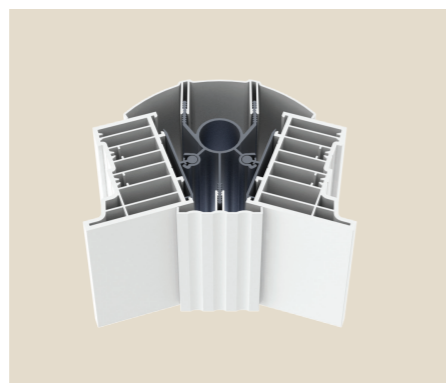

482055 160°-180° Variable Bay Post
482104 Frame Adapter
DBI, DBO Internal, External Trim
Jack C 482055

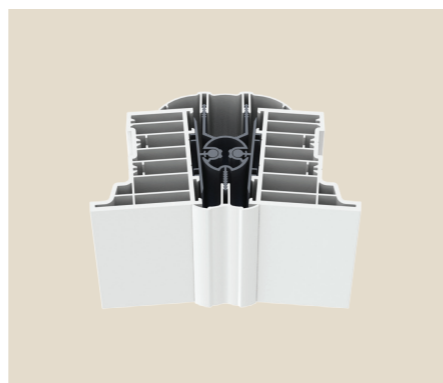

R103 Mullion Stiffening
- Use with R001
R204 Trim



R104 Mullion Stiffening
- Use with R001, R001M
R203 Trim

